

OWNER'S MANUAL

TrailMate™

Connoisseur Series Gas Grill
Model A10-801



For questions regarding performance, assembly, operation, parts, or returns, contact the experts at MAGMA by calling **(562) 627-0500**

7:00 a.m. - 5:00 p.m. Pacific Time Monday thru Friday or e-mail us at mail@magmaProducts.com



Read these instructions carefully before use. Familiarize yourself with the appliance before connecting it to its gas container. Keep these instructions for future reference.

IMPORTANT SAFETY WARNINGS

READ ALL INSTRUCTIONS BEFORE OPERATING.

- USE OUTDOORS ONLY.
- DO NOT USE THIS APPLIANCE INSIDE THE BOAT OR ANY ENCLOSED SPACE.
- GRILLS RADIATE HEAT. CLEARANCE FROM COMBUSTIBLES, 24" SIDES AND BACK. NEVER USE UNDER AWNINGS, PATIO COVERS, ETC.
- USE PROPANE GAS ONLY. FUEL STORAGE SHOULD BE IN COMPLIANCE WITH THE AMERICAN BOAT AND YACHT COUNCIL (ABYC) STANDARDS A-1 (9), MARINE LIQUIFIED PETROLEUM GAS (LPG) SYSTEMS.
- FOR NATURAL GAS APPLICATION CONTACT MAGMA.
- ALWAYS LIGHT GRILL WITH LID OPEN.
- NEVER LEAVE HOT GRILL UNATTENDED.
- USE HOT PAD WHEN HANDLING.
- ALWAYS TURN GRILL OFF AFTER USE.
- NEVER LEAVE GAS CYLINDERS AND REGULATOR CONNECTED WHEN STOWED.
- STORE GAS CYLINDERS IN WELL VENTILATED AREA.
- DO NOT STORE GAS CYLINDERS INDOORS, IN DIRECT SUNLIGHT, BELOW DECKS ON BOATS, OR IN LOCKERS NOT APPROVED FOR BUTANE OR PROPANE STORAGE.
- CAUTION: CHECK FOR GAS LEAKS EACH TIME CYLINDER IS CHANGED.
- NEVER CHECK FOR GAS LEAKS WITH A FLAME!
- DO NOT BLOCK, RESTRICT, OR OTHERWISE OBSTRUCT COMBUSTION OR VENTILATION AIR OPENINGS.
- DO NOT MODIFY THIS APPLIANCE.
- CHECK THAT VALVE SEALING WASHER (A) IS IN PLACE AND IN GOOD CONDITION BEFORE CONNECTING THE GAS CONTAINER.
- INSTALL CANISTERS IN WELL VENTILATED AREA AND AWAY FROM OPEN FLAME, HEAT SOURCE OR SPARKS. KEEP AWAY FROM OTHER PEOPLE OR FLAMMABLE MATERIALS.



Each Magma® Gas Grill is individually fire tested before it leaves the factory. For this reason, the burner on your grill may be slightly discolored.

INSTALLATION INSTRUCTIONS

CONTROL VALVE REGULATOR

- Uses standard 1-lb. disposable propane canisters (DOT-39 NRC 228/286).
- Prior to installing valve, become familiar with the valve function & graphics on valve knob. Never force the knob. Always turn or push gently.
- Turn control valve to "lock" and install gas canister being careful not to cross the threads. Check for leaks prior to use, by brushing soapy water solution around threads and orifice hole checking for bubbles.
- Position valve with gas bottle as shown (A). Gently insert valve stem into valve chamber. Rotate until valve stem key aligns with lock detent allowing valve to fully insert. Rotate gas canister down, so knob faces you (B) or straight up (C) depending on application. Pull straight out on valve to check that it is locked in place.

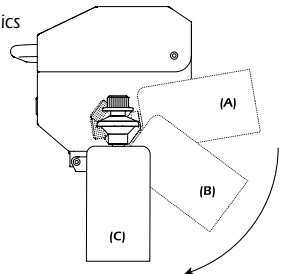

Valve will feel loose and will rotate easily. Even though the valve feels loose, it is designed that way and will not leak. The valve was designed to be loose fitting in order to allow safe, easy installation and removal of the propane canister and so it easily swings without resistance to fit all applications

MOUNT HARDWARE

Fasteners are supplied for Single Mount grill mounting options.
See Magma Catalog or Website for best mount selection.

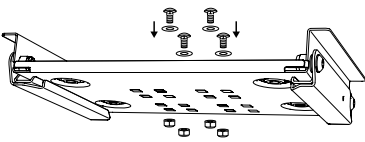

Single mount through-bolt applications

4 Carriage bolts, washers & lock nuts.

Note: Place washers on carriage bolts as shown above..



Carriage bolt,
washer & lock nut

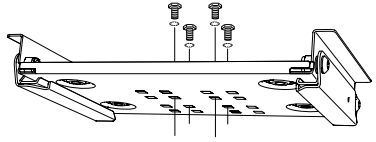

Single mount non-through-bolt applications, including Style 1 "Levellock"

4 Hex head bolts & lock washers.

Note: Place lock washers on hex bolts as shown above.

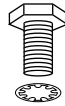

Hex head bolt
& lock washer

See Magma website for
replacement part numbers
and valve applications.
www.MagmaProducts.com

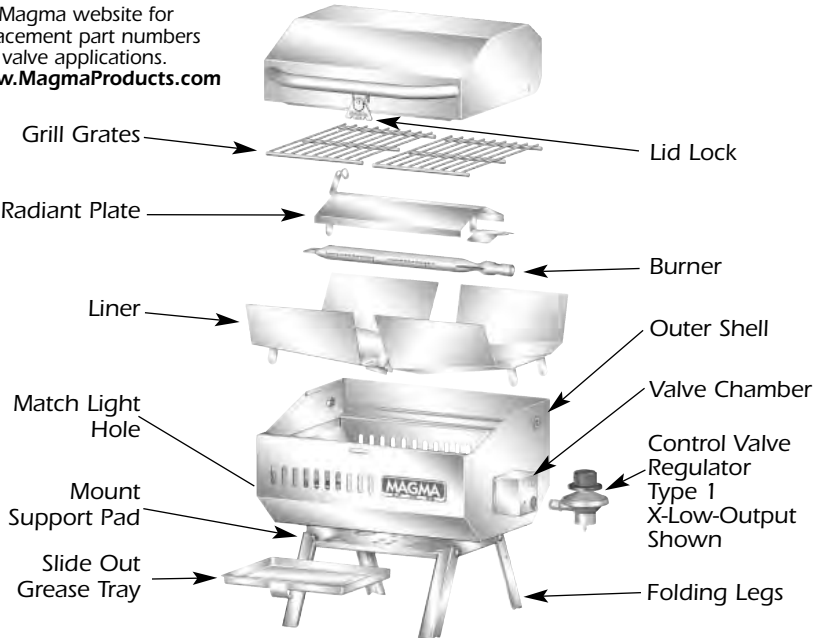

OPERATING PROCEDURES

OPERATE ONLY ON "LOW" WHEN LID IS CLOSED. ALWAYS OPERATE WITH GREASE TRAY IN PLACE.

WARNING: Do not overheat grill. Magma Grills do not require pre-heating. Stainless Steel loses anti-corrosive characteristics when subjected to extreme heat. Most grilling is done on low temperature with the lid closed. If medium or high heat is required, grill with lid open.

LIGHTING INSTRUCTIONS

- Open lid during lighting.
- Place flame up to burner through the match light hole.
- Depress valve and turn counter-clockwise to the "HIGH".
- Visually confirm ignition.

TO REDUCE FLARE-UP

- Empty and clean grease tray prior to each use.
- Trim excess fats from meat.
- Use non-oil based marinades.
- Reduce heat.
- Use water spray directly on flare-ups.

NOTE: Before lighting, lid lock must be positioned not to engage. Open lid and turn lock to locked position, or bring lock latch up to handle in open position and flip lock actuator back onto handle.

PRACTICAL HINTS:

Before lighting your grill, be sure that ...

- Grill is secure and properly mounted.
- Internal components and grease tray are clean and correctly positioned.
- You have plenty of gas in the canister.
- Gas canister is attached properly and there are no gas leaks.
- Lid lock has been set not to engage.
- You have a water spray bottle handy to cool a hot grill or stop any flare-ups.

STOWING TIPS

- Always disconnect the fuel canister from the valve prior to stowing.
- Stow the valve in a clean, dry area to protect from corrosion to valve.
- Always store propane in a sealed propane storage locker that allows leakage to vent overboard or use **Magma A10-210 Propane Storage Tote**.
Never stow below decks

DISASSEMBLY & RE-ASSEMBLY

- A** - Lift radiant plate up & out of left slot.
- B** - Remove by sliding it out of right slot.
- C** - Remove burner screw and remove burner. Check burner for grease residue or spider webs that may obstruct gas flow. **CAUTION: WHEN REPLACING BURNER, CUT SLOTS IN BURNER MUST FACE DOWN.**
- D** - Lift the two-section liner out of outer shell by lifting up on the burner support bracket on the left liner section. **(1)** Slide the left section partially over the right section. **(2)** Grab the back of the left liner section and pull it toward you until it clears the lip of the outer shell. **(3)** Lift liner section out of grill.
- E** - Move the right liner section slightly to the left **(1)**. Grab the back of this section and pull it toward you **(2)** - lift and remove this section **(3)**.
- Inspect burner, remove any obstructions.
 - Clean as indicated in Maintenance (page 6).
 - To re-assemble, reverse the procedure above.

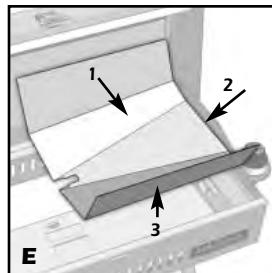
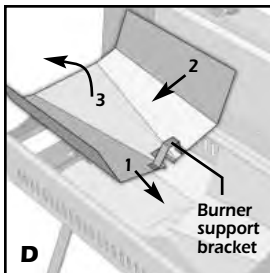
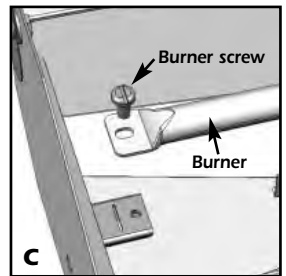
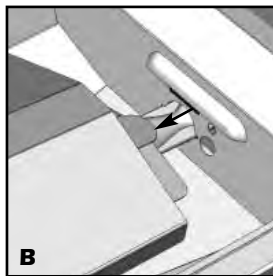
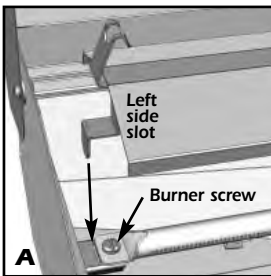

MAINTENANCE

Stainless Steel, contrary to popular belief, can rust. Most commonly, deposits on the surface of the product will trap moisture. It is this moisture that robs the stainless steel of oxygen. Oxygen is the element that reacts with the stainless steel to form a protective layer of chrome oxide. Robbed of oxygen this reaction does not take place and “crevice corrosion”, or “surface rusting”, occurs. To minimize this effect, thoroughly clean your grill with soap and water, rinse with fresh water and dry. Avoid using products designed to clean stainless steel as most leave a residue that may discolor when the grill is heated.

Additionally, stainless steel that is exposed to high heat will change in color and texture over time. This “bluing” and later “browning” of the internal components is not a failure of the stainless steel and will not affect the product operation. However, prolonged exposure to extreme high heat will cause the chromium and nickel to “burn out” of the stainless steel. At this point the stainless steel will become more susceptible to corrosion and will start to deteriorate. We recommend that you replace these internal components if they become seriously deteriorated.

We recommend thorough cleaning of all internal parts after each outing. It is important to disassemble the interior components and remove any food residue. A soft “Scotchbrite” pad or similar product may be used in this process. For heavier burned-on stains we recommend “Easy-Off Oven & Grill Cleaner” followed by thorough washing with soap and water, rinse with fresh water and dry. **AVOID CONTACT OF OVEN CLEANER WITH CONTROL VALVE, IGNITER ELECTRODE & WIRE, AND BOAT SURFACES. CAUTION: DO NOT USE ANY TYPE OF ABRASIVE PAD ON THE EXTERIOR MIRROR FINISH AS IT WILL SCRATCH THE SURFACE. USE ONLY A SOFT COTTON CLOTH.** We recommend covering the grill between uses. Grill covers are available at Magma retailers or directly from Magma. See our website, www.MagmaProducts.com.

Grill Grates - Clean with brass wire brush while grill is warm. Use Oven & Grill cleaner for burnt-on residue. Wash with soapy water and dry prior to storage.

Control Valve - All valves are set and tested at our factory. Do not attempt to adjust or disassemble the valve in any way. Call Magma if you suspect it is not adjusted properly. Clean valve with a cloth and remove any debris obstructing the orifice.

Repair/Replacement Parts - All replacement parts are readily available at your Magma Retailers or directly from Magma. For a complete list of replacement parts visit our website www.MagmaProducts.com.

USING GRILL WITH ON-BOARD LPG (PROPANE) SYSTEMS

▪ Magma On-Board LPG (Propane) Valves and Hose Kits allow Magma Grills to be installed within a boat's existing on-board, pre-regulated low pressure LPG (Propane) system.

▪ Use only **Magma Type 3 Low Pressure LPG (Propane) Valves**. See our **Valve Application Guide** at www.MagmaProducts.com for correct valve.

▪ In North America use **Magma A10-225 LPG 10' Hose Kit** in conjunction with **Type 3 Valve**. Outside North America check your local dealer for proper hose and fittings.

▪ A primary shutoff valve (**supplied with A10-225 hose kit**) must be used with this control valve at point of connection into your system. This allows shut off of gas supply to hose leading to grill.

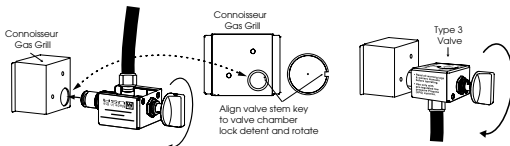

Insert valve as shown in diagram above. Valve may seem loose, this is OK. Valve does not have to be snug-fitting to be safe or function properly.

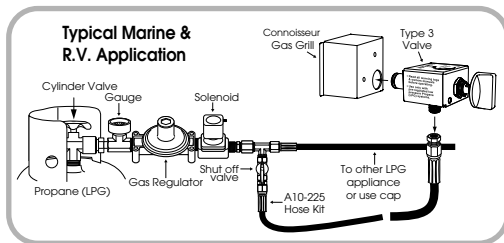

IMPORTANT!!

▪ **DO NOT CONNECT A HIGH-PRESSURE SUPPLY HOSE FROM A NON-REGULATED TANK DIRECTLY TO GRILL.**

Magma's grills are designed for use with small disposable propane canisters or with pre-regulated low-pressure propane and optional low-pressure valves. Running high-pressure propane fuel supply lines on a boat is in violation of American Boat & Yacht Council (ABYC) guidelines and is not considered a safe application. Additionally, impurities found in larger refillable propane tanks may clog the small orifices in the high-pressure control valve/ regulator causing it to lose performance capabilities and eventually fail. Regulating these tanks to 1/2 PSI and using this pre-regulated propane with the correct low-pressure valve will insure safe, efficient performance of the grill.

USING GRILL WITH ON-BOARD CNG (NATURAL GAS) SYSTEMS

- For on-board CNG (Natural Gas) Systems, use Magma Type 4 X-Low Output - Low Pressure Natural Gas Control Valve. Check your local dealer for proper hose and fittings.

TROUBLE SHOOTING GUIDE

Problem	Possible Cause	Possible Solution
Burner will not light with match	No gas flow Obstructed gas flow	Check fuel level, replace canister or refill cylinder Clean burner and valve orifice. Remove debris/spider webs
Flare-up	Excessive cooking temperature Grease and/or residue build-up Excessive fat in meats Excessive oils in marinades	Operate only on low when lid is closed Reduce flame level Leave lid open Use water spray to cool Clean components Trim fat from cuts of meat before grilling Use non-oil based marinades
Yellow sooty flame	Obstructed gas flow	Clean burner and valve orifice. Remove debris/spider webs
Blow-out	Flame too low Wind directly on burner Obstructed gas flow	Increase flame Block wind when opening lid Clean burner and valve orifice. Remove debris/spider webs
Hot Spots	Grill not level Grease or residue build-up Excessive fat in meats Excessive oil in marinades	Level Grill Clean components Trim fat from cuts of meat before grilling Use non-oil based marinades

Contents

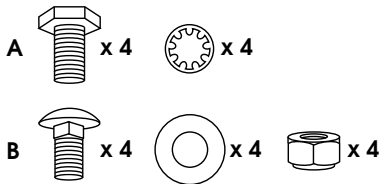
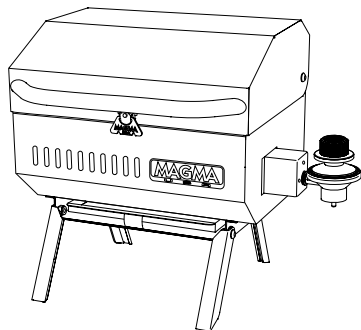

A) Pack of (4) 1/4"-20 x 5/8" hex head screws and internal lock washers for "Levellock" single mount application.

B) Pack of (4) 1/4"-20 x 5/8" carriage bolts, washers and lock nuts for dual mount and single mount applications and table legs.

LIMITED WARRANTY

Magma Products, Inc. guarantees this product to be free from defects in materials or workmanship to the original consumer. This guarantee is for the periods herein specified when used under normal and reasonable conditions, one (1) year from the date of original purchase. This warranty does not include the cost of property damage or any inconvenience due to the failure of the product. Nor does it cover damage due to misuse, abuse, accident, or damage resulting from transportation of the product. Nor does it include damage resulting from the commercial use of this product. Nor does it include, on stainless steel products, "Surface Rust"; Excessive Corrosion due to exposure to salt water; or Discoloration or Corrosion caused by exposure to excessive heat or failure to properly clean and care for the stainless steel surfaces. If the product fails to operate due to a defect in materials or workmanship during the warranty period, the defective part will be repaired or replaced at Magma's option. If you wish to obtain performance under this limited warranty, you should contact Magma's Customer Service Department via telephone at (562) 627-0500, or via e-mail at mail@MagmaProducts.com, or via U.S. Postal Service mail at "Magma Products, Inc., Attention Customer Service, 3940 Pixie Ave. Lakewood, CA, 90712". The defective part, along with proof of purchase, must be returned postage prepaid to Magma Products, Inc. We suggest that you keep your purchase receipt as we may require reasonable proof of purchase.

In the state of California only, if refinishing or replacement of the product is not commercially practicable, the retailer selling the product, or Magma Products, Inc., will refund the purchase price paid for the product, less the amount directly attributable to use by the original consumer prior to the discovery of the nonconformity. In addition, in the state of California only, you may take the product to the retail establishment from which it was purchased or to any retail establishment selling this product in order to obtain performance under this warranty. All implied warranties, including the implied warranties of merchantability and fitness for a particular purpose, are limited in duration to the express warranty periods specified herein for the parts described herein. Some states do not allow limitations on how long an implied warranty lasts, so the above limitation may not apply to you. Neither Magma dealers, nor the retail establishment selling this product has any authority to make any warranties or to promise remedies in addition to or inconsistent with those stated above. Magma's maximum liability shall not exceed the purchase price of the product paid by the original consumer. Some states do not allow the exclusion or limitation of incidental or consequential damages, so the above limitation or exclusions may not apply to you. The warranty gives you specific legal rights and you may also have other rights which vary from state to state.

MAGMA and the Magma logo are registered trademarks of Magma Products, Inc.

TrailMate is a trademark of Magma Products, Inc.

Patent pending.

CALIFORNIA PROPOSITION 65 – WARNING – The burning of gas cooking fuel generates some by-products, which are on the list of substances, which are known by the State of California to cause cancer or reproductive harm. California law requires businesses to warn customers of potential exposure to such substances. To minimize exposure to these substances, always operate this unit according to the use and care manual, ensuring you provide good ventilation when cooking with gas.



Magma Products, Inc.

3940 Pixie Avenue, Lakewood, CA 90712 ■ USA

Phone (562) 627-0500 ■ e-mail: mail@MagmaProducts.com

www.MagmaProducts.com

MAGMA PRODUCTS, INC. • 3940 Pixie Avenue • Lakewood, CA 90712 • U.S.A.
Phone (562) 627-0500 • International Phone +01 562 627 0500
Fax: (562) 627-0550 • International Fax +01 562 627 0550
www.MagmaProducts.com • e-mail: mail@MagmaProducts.com

Addendum to the A10-803CE-2, ChefsMate Manual for use with Model A10-801CE-2, TrailMate.
L'addendum à l'A10-803CE-2, Manuel de ChefsMate pour l'usage avec Modèle A10-801CE-2, TrailMate.
Nachtrag zum A10-803CE-2, ChefsMate Handbuch für Gebrauch mit Entwurf A10-801CE-2, TrailMate.
El apéndice al Manual de ChefsMate A10-803CE-2, para el uso con TrailMate A10-801CE-2, Modelo.
L'addendum all'A10-803CE-2, il Manuale di ChefsMate per l'uso con Modella A10-801CE-2, TrailMate.
Addendum naar het A10-803CE-2, Chefsmate Handboek voor gebruik met Modelleer A10-801CE-2, Trailmate.

ENGLISH

OWNER'S MANUAL Connoisseur Series Gas Grills A10-801CE-2 - TrailMate™

Page 3 MOUNT HARDWARE

Fasteners are supplied for Single Mount grill mounting options. See Magma Catalog or Website for best mount selection.

Single mount through-bolt applications

4 Carriage bolts, washers & lock nuts. Note: Place washers on carriage bolts as shown above.

Single mount non-through-bolt applications,

including Style 1 "Levelock" 4 Hex head bolts & lock washers. Note: Place lock washers on hex bolts as shown above.
Carriage bolt, washer & lock nut / Hex head bolt & lock washer

Grill Grates / Radiant Plate / Liner / Match Light Hole / Mount Support Pad / Slide Out Grease Tray / Lid Lock / Burner / Outer Shell / Valve Chamber / Control Valve Regulator Type 2 X-Low-Output Shown / Folding Legs www.MagmaProducts.com

FRANCAIS

MANUEL D'UTILISATION Barbecue au gaz Connoisseur Series A10-801CE-2 - TrailMate™

Page 3 Fixation du barbecue

Des attaches sont fournies tant pour un montage simple du barbecue que pour un montage double.
Veuillez consulter le catalogue de Magma ou le site Internet pour trouver le bon type de fixation.

Les applications seules de par-boulon de montage

4 boulons d'attelage, les rondelles & verrouille des noix. Note : Placer des rondelles sur les boulons d'attelage comme indiqués.

Le montage seul non-par-les applications de boulon, y compris Concevoir 1 « Levelock »

4 boulons de tête de Sort & verrouille des rondelles. Note : Placer des rondelles frein sur les boulons de sort comme indiqués.

Le boulon d'attelage, la rondelle & verrouille la noix / Le boulon de tête de sort & verrouille la rondelle

Grille chauffante / Plaque de radiation / Paroi intérieure / Hublot d'allumage des allumettes / Plaque-support de montage / Bac de récupération coulissant / Verrouillage du couvercle / Grilles du barbecue / Brûleur / Paroi extérieure / Chambre de la valve / Le Régulateur de Soupape de contrôle Tape 2 X-le niveau bas-Sort Montré / Plier Jambes / Veuillez consulter le site Internet pour connaître les numéros actuels des pièces. www.MagmaProducts.com

DEUTSCH

GEBRAUCHSANLEITUNG Connoisseur Seriengasgrill A10-801CE-2 - TrailMate™

Seite 3 DEN GRILL BEFESTIGEN

Es sind sowohl Befestigungen für einfache als auch doppelte Montage des Grills vorhanden. Siehe den Magma-Katalog oder die Webseite für den richtigen Befestigungstyp.

Heben Sie Untersätze durch Schraubenwendungen

4 Kutschen Schrauben, Unterlegscheiben heraus & verschließt Müttern. Anmerkung: Stellen Sie Unterlegscheiben auf Kutschenschrauben wie gezeigt.

Heben Sie Untersatz nicht-durch-Schraube Anwendungen, heraus schließt 1 „Levelock“

4 Sechskantkopfschrauben & Unterlegscheiben Gestaltet verschließt mitein. Anmerkung: Stellen Sie Schlösserunterlegscheiben auf Sechskantschrauben wie gezeigt.

Kutschenschraube, Unterlegscheibe & verschließt Mutter / Sechskantkopfschraube & verschließt Unterlegscheibe

Aufwärmrost / Strahlungsplatte / Innenmantel / (Streichholz)Zündöffnung / Montageplatte / Ausziehbare Tropfschale / Deckelverriegelung / Grillroste / Brenner / Außenmantel / Ventilkammer / Steuerventilregulierapparat 2 X-Tiefpunkt-Ausgangs Gezeigt / Falten Lüft / Siehe Webseite für aktuelle Ersatzteilnummern. www.MagmaProducts.com

ESPAÑOL

MANUAL DE USO Barbecue a gas Connoisseur Series A10-801CE-2 - TrailMate™

Página 3 MONTAR LA PARRILLA

Hay sujetadores tanto para el montaje simple como doble de la parrilla. Véase el catálogo de Magma o sus páginas web para el tipo de sujeción correcto.

Solas aplicaciones del por-cercojo del monte

4 cerrojos del Coche, las arandelas & cierra nueces. La nota: Coloque arandelas en cerrojos de coche como mostrado.

Solo monte no por aplicaciones de cerrojo, inclusive Estiliza 1 "Levelock"

4 cerrojos de cabeza de Mal de ojo & cierra arandelas. La nota: Coloque arandelas de cerradura en cerrojos de mal de ojo como mostrado.

El cerrojo del coche, la arandela & cierra nuez / El cerrojo de la cabeza del mal de ojo & cierra arandela

Parrilla calentaplato / Placa radiante / Caja interior/Apertura de encendido con fósforo / Placa de soporte para el montaje / Bandeja colectora extraíble / Cerradura de la tapa / Parrillas / Quemador / Caja exterior / Cámara de válvula / Control de Válvula de tipo Regulador 2 Bajo de salida de X Mostrado / Doblar Piernas / Para ver los números de piezas de recambio actuales, véanse nuestras páginas web. www.MagmaProducts.com

ITALIANO

ISTRUZIONI PER L'USO Grill a Gas Connoisseur serie A10-801CE-2 - TrailMate™

Pagina 3 FISSAGGIO DEL GRILL

Esistono degli speciali dispositivi di fissaggio, sia per il montaggio semplice del grill, sia per quello doppio. Per scegliere il giusto tipo di sistema, s'invita a consultare il catalogo Magma, sul sito Web.

Separare le domande di attraverso-bullone di monte

4 bulloni di Trasporto, le rondelle & chiude a chiave le noci. Nota: Collocare le rondelle sui bulloni di trasporto come mostrato.

Separare il monte non-attraverso-le domande di bullone, includendo lo Stile 1 "Levelock"

4 bulloni di testa di Hex & chiude a chiave le rondelle. Nota: Collocare le rondelle di serratura sui bulloni di hex come mostrato.

Il bullone di trasporto, la rondella & chiude a chiave la noce / Il bullone di testa di Hex & chiude a chiave la rondella

Ripiano scaldavivande / Piastra radiante / Rivestimento interno / Apertura per l'accensione con fiammiferi / Piastra di supporto per il montaggio / Vassoio raccogligrassa scorrevole / Chiusura del coperchio / Graticole / Bruciatore / Rivestimento esterno / Alloggiamento della valvola / Controllare il Tipo di Regulator di Valvola 2 X-di Uscita Bassa Mostrata / Gambe di piegare www.MagmaProducts.com

NEDERLANDS

GEBRUIKERSHANDLEIDING Connoisseur De Serie Gas Grill A10-801CE-2 - TrailMate™

Pagina 3 DE GRILL BEVESTIGEN

Er zijn bevestigingen aanwezig voor zowel enkelvoudige als dubbele montage van de grill. Zie de Magma-catalogus of de website voor het juiste type bevestiging.

Kies berg door-bout toepassingen 4

Rijtuigen bouten, sluitringen uit & sluit noten af. Merk op: Plaats sluitringen op rijtuig bouten zoals getoond.

Kies berg niet-door-bout toepassingen, inclusief Stileer 1 "Levelock"

4 Beheksing hoofd bouten uit & sluit sluitringen af. Merk op: Plaats leertjes op beheksing bouten zoals getoond.

De rijtuig bout, sluitring & sluit noten af / De beheksing hoofd bout & sluit sluitring af

Opwarmrek / Stralingsplaat / Binnenmantel / Luciferaansteekopening / Montagesteunplaat / Uitschuifbare Iekbak / Dekselvergrendeling / Grillroosters / Brander / Buitenmantel / Klepkamer / Controleer Klep Regelaar Type 2 X-Dieptepunt-Voortbrengt Getoond / Vouwend Benen www.MagmaProducts.com