

Simpson Davits

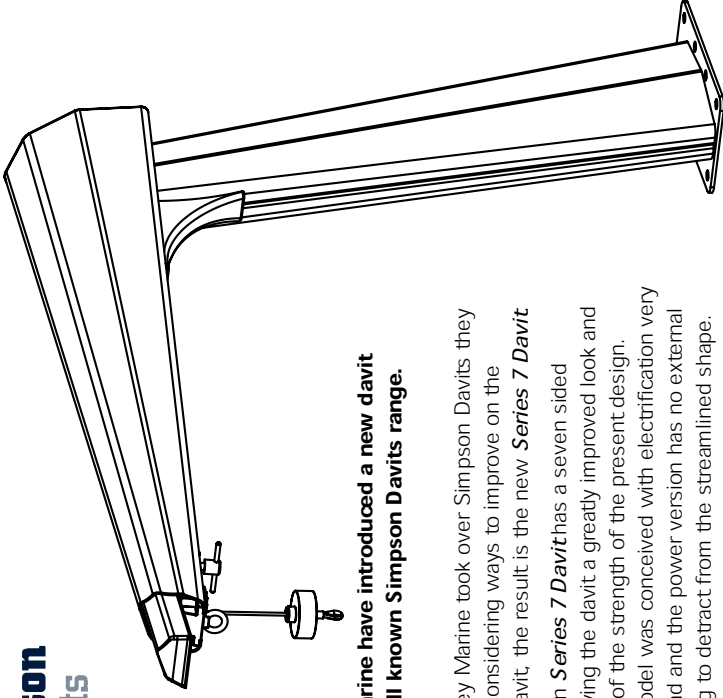

Cooney Marine have introduced a new davit to their well known Simpson Davits range.

Since Cooney Marine took over Simpson Davits they have been considering ways to improve on the traditional davit, the result is the new **Series 7 Davit**. The Simpson **Series 7 Davit** has a seven sided structure giving the davit a greatly improved look and retaining all of the strength of the present design.

The new model was conceived with electrification very much in mind and the power version has no external motor casing to detract from the streamlined shape.

Power winches have historically been avoided on sailing yachts due to the battery capacity on board, but this unit is designed to keep current drain to a minimum and make the powered option a first choice especially as manual override is fitted as standard.

The **Series 7 Davit** comes in standard, long reach and tall configurations (tall only available on S225/250 models) with lifting capacities from 150kg to 300kg per pair of davits (manual and electrical versions available).

White painted version also available.

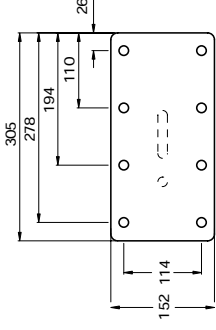

Baseplate S225, S225 Tall, S250, S250 Tall, S300

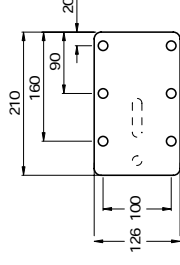

Baseplate S150, S175

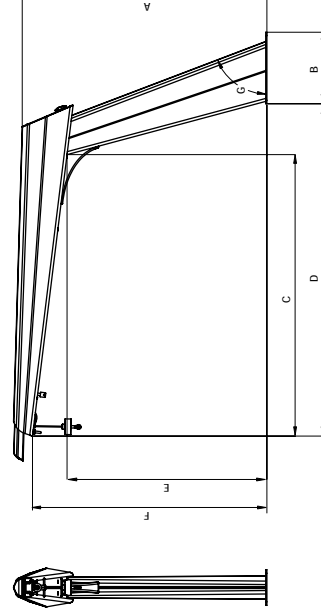

MODEL	SWL per pair	A	B	C	D	E	F	G
S150	150kg	712	210	880	1015	535	650	68
S175	175kg	727	210	1245	1380	535	660	68
S225	225kg	866	305	1200	1410	665	795	68
S225 Tall	225kg	1045	305	1200	1455	850	970	68
S250	250kg	857	305	1045	1260	665	785	68
S250 Tall	250kg	1045	305	1045	1305	850	945	68
S300	300kg	1045	305	1200	1455	850	970	68









SERIES 7 DAVITS

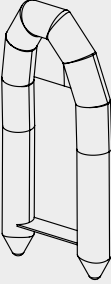

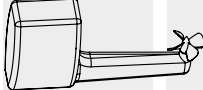
DAVIT SELECTION

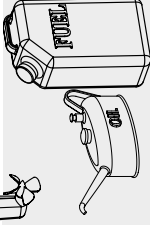

Calculate the **TOTAL weight (kg)** to be carried by the davits, this includes:-

1. The Dinghy		=		_____
2. The Engine		=		_____
3. Engine Fluids		=		_____
4. Equipment		=		_____
TOTAL WEIGHT		=		_____

 Lifting Wt	<50	<75	<100	<125	<150	<175	<200	<225	<250	<300
S-type					S 150	S 175	S 225	S 225	S 250	S 300
D-type			D 100	D 125	D 150	D 175	D 200	D 225	D 250	
SD-type	LSD 50	LSD 75			LSD 125					
Reach (mm)		805	1090	880	1245	1045	1200	1045	1045	1210
Reach SD (mm)	782	974		974						

DAVITS ACCESSORIES

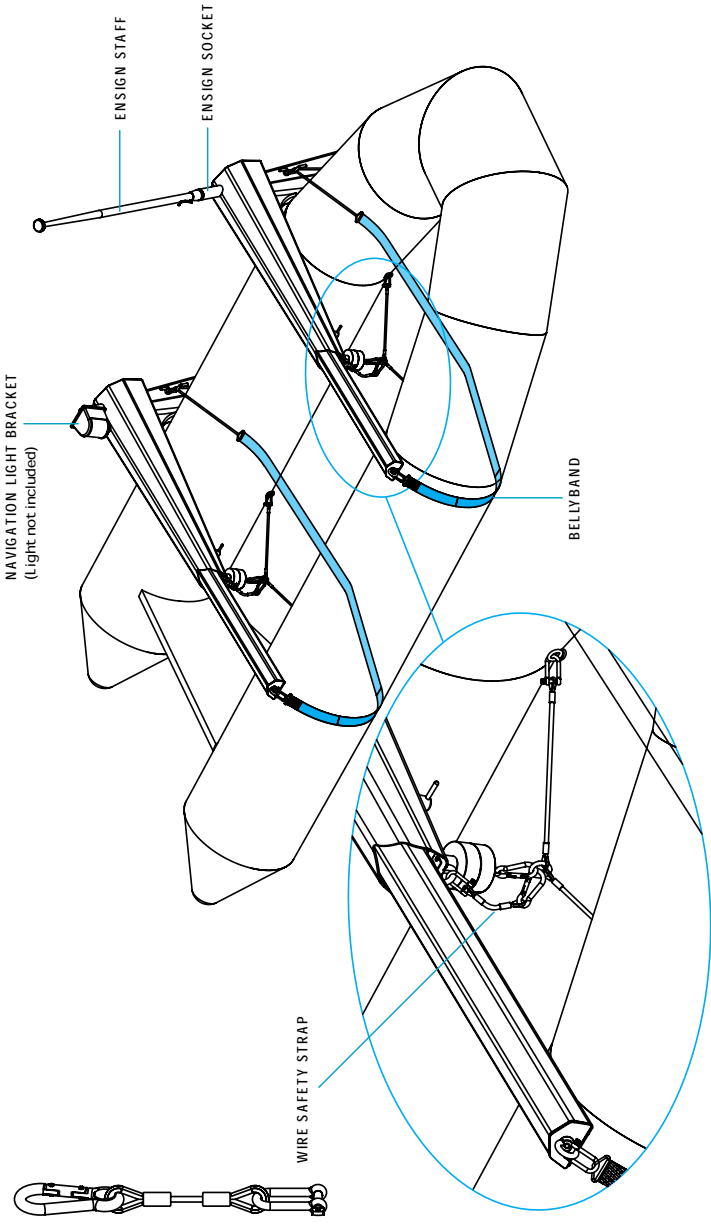

Transom Brackets

Standard transom brackets for use on vertical transom.
Custom made transom brackets are available to suit all stern shapes and have the same features as the standard brackets.

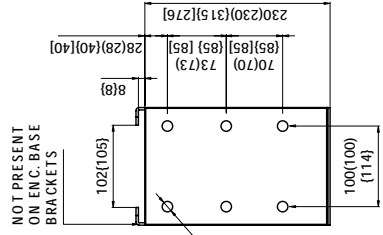
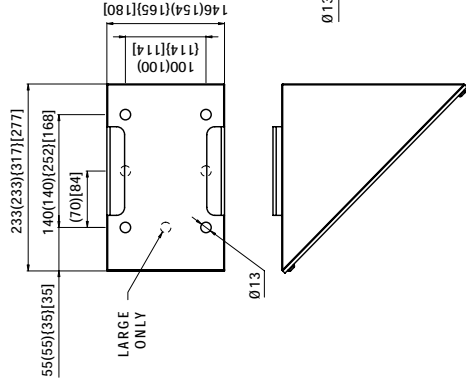
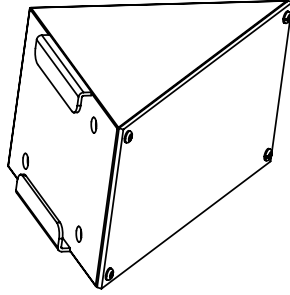

DAVIT ACCESSORIES (SIMPSON DAVITS)

PART NUMBER	DESCRIPTION
X 02063	2m Bellyband S trap 100 & 150
X 02064	2.5m Bellyband S trap 200 & 250
X 02065	3m Bellyband S trap 125, 175, 225 & 300
X 04090	Wire Safety S trap Set
DA 9301	Transom Brackets Std S small
DA 9302	Transom Brackets Std Large
X 00212	Custom Transom Brackets S small
X 00712	Custom Transom Brackets Large

DAVITS ACCESSORIES



Interlock Blocks

Patented neoprene block for easy fitting to the dinghy to ensure stability and chafe-proof stowage. Available in black or grey.

Series 7 Interlock Block

1 set = 2 Blocks, 2 Location Pads and 2 Rubbing Strips.

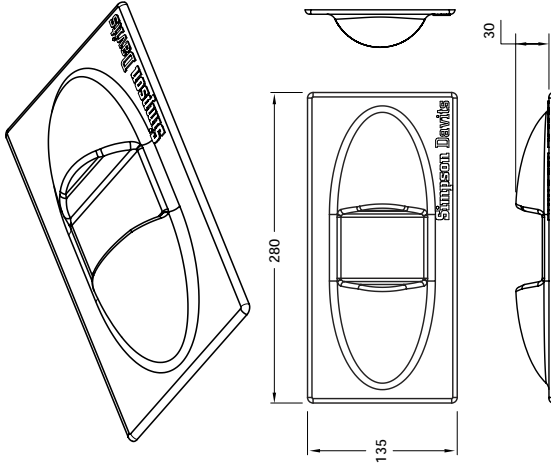

Interlock Block Location Pad

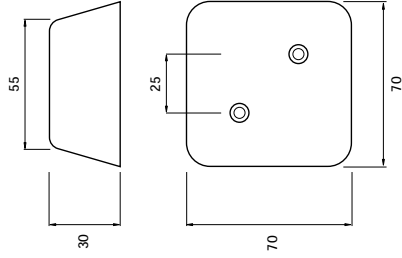

Ensign Staff

Standard Tapered

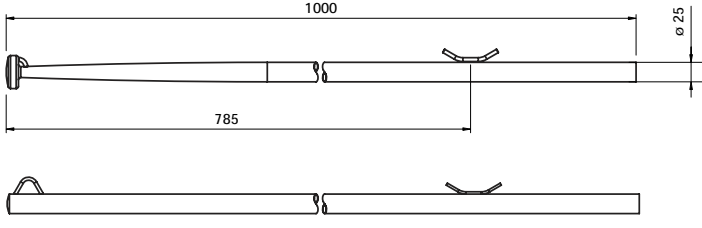

DAVIT ACCESSORIES (SIMPSON DAVITS)

PART NUMBER	DESCRIPTION
DA 9201	Deck Shoe - Small
DA 9202	Deck Shoe - Large
DA 9550	Interlock Block Glue
DA 9901	Davit Packing 100 & 150
DA 9902	Packing LSD Davits & Gangways
DA 9904	Davit Packing 125 & 175
DA 9905	Davit Packing 200, 225 & 250
A 227-019	Interlock Block for S7 Davits Grey Only
X 03945	Ensign Socket
X 03943	Ensign Staff 1m
X 03944	Ensign Staff Tapered 1m
X 03891	Navigation Light Bracket